

Peveeta Commercial Doors: Engineered for Power, Crafted for Perfection



MULTI FUNCTIONAL STEEL DOORS

- GENERAL PURPOSE DOORS
- FIRE RATED DOORS
- CLEAN ROOM DOORS
- HOSPITAL DOORS
- LEAD LINE DOORS
- ACOUSTIC DOORS
- FLIP FLOP DOORS
- SHAFT DOORS

VALUES OF PEVEETA

Craftsmanship Excellence: We are committed to delivering top-tier quality, ensuring every steel door is a testament to precision, durability, and artistry.

Innovation: We embrace forward-thinking approaches to design and manufacturing continually improving our processes and products.

Customer-Centricity: Our customers are at the heart of everything we do, and we strive to meet their needs with tailored solutions and exceptional service.

Integrity: We operate with honesty, transparency, and accountability in all aspects of our business.

Sustainability: We are dedicated to eco-friendly practices, minimizing our environmental impact through responsible sourcing and efficient manufacturing.

Safety and Security: Our products are designed with the utmost priority on safety, ensuring that they provide robust protection without compromising on aesthetics.

Team Collaboration: We foster a collaborative environment where ideas are shared, and teamwork drives our success.

PRODUCT FEATURES

Durability: Engineered to withstand heavy use and harsh environmental conditions, ensuring long-lasting performance.

Security: Equipped with advanced locking systems and reinforced structures to provide maximum security for commercial spaces.

Fire Resistance: Available in fire-rated options, these doors help protect property and lives in case of emergencies.

Energy Efficiency: Insulated designs that help maintain indoor temperatures, reducing energy costs and enhancing comfort.

Customized Design: Offered in a variety of styles, finishes, and sizes to meet specific architectural and aesthetic requirements.

Low Maintenance: Constructed with corrosion-resistant materials, requiring minimal upkeep to maintain appearance and functionality.

Acoustic Performance: Designed to reduce noise transmission, making them ideal for offices, restaurants and other commercial environments.

Easy Installation: Pre-hung options available for quick and efficient installation, minimizing downtime for businesses.

Our Seamless Process, Your Trusted Commercial Steel Door Solution

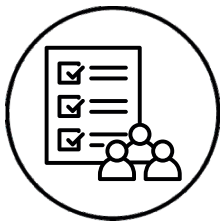

**Customer
Requirement
Assessment**



**Detailed
Solutions Offered**

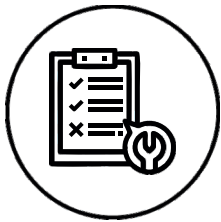

**Site Survey
By
Technical Team**



Fabrication



Delivery

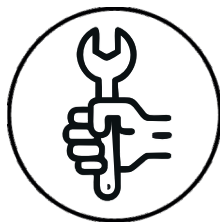

**Installation
at Site**



Dedicated After-Sale Services



GENERAL PURPOSE DOORS



Material

Galvanized Steel
Stainless Steel

Sheet Thickness

Frame - 1.2 mm
Shutter - 0.8 mm

Optional Sheet Thickness

Frame - 1.6 / 2.0 mm
Shutter - 1.2 / 1.6 mm

Frame Size

Standard - 102 x 56 mm / 125 x 56 mm

Shutter Thickness

Infill

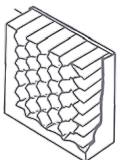

HONEY COMB

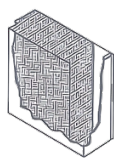

MINERAL WOOL

Vision Panel

200 x 300 mm
150 x 750 mm
450 x 750 mm



Louver

450 x 300 mm
450 x 200 mm

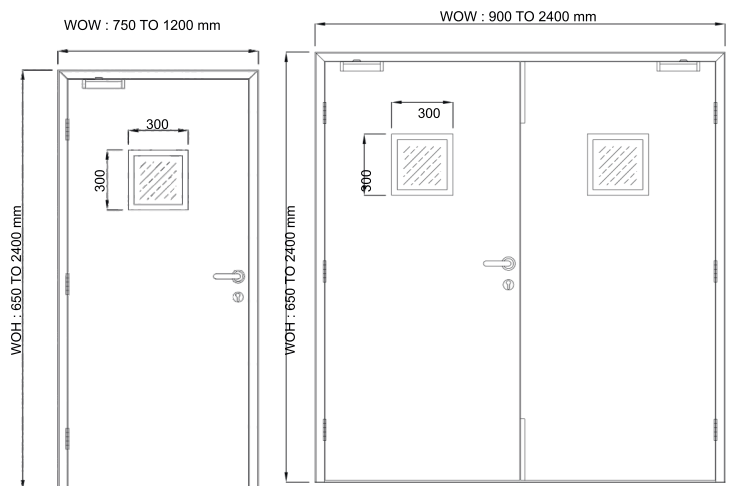

WOW - Wall Opening Width
WOH - Wall Opening Height

Application

- Institutions
- Hospitals
- Public Buildings
- Commercial Buildings
- Airports/Metro

FIRE RATED DOORS



Material

Galvanized Steel
Stainless Steel

Sheet Thickness

Frame - 1.6 mm
Shutter - 1.2 mm

Optional Sheet Thickness

Frame - 2.0 mm
Shutter - 1.6 mm

Frame Size

Standard - 102 x 56 / 125 x 56 mm
Optional - 147 x 56 mm (Double Rebate)

Shutter Thickness

46 mm / 50 mm

WOW : 750 TO 1200 mm

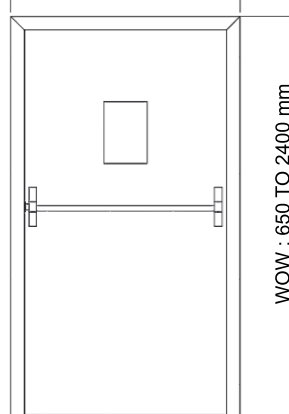

WOW : 900 TO 2400 mm

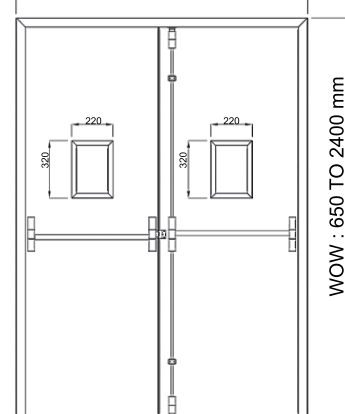

Vision Panel

200 x 300 mm
300 x 300 mm

WOW - Wall Opening Width
WOH - Wall Opening Height

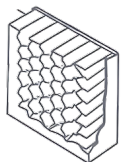

HONEY COMB

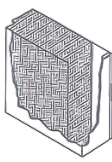

MINERAL WOOL



Clear Vision Lite for up to
120 Minutes Fire Rating



Application

- Institutions
- Hospitals
- Public Buildings
- Commercial Buildings
- Airports/Metro



CLEAN ROOM DOORS



Material

Galvanized Steel
Stainless Steel

Sheet Thickness

Frame - 1.2 mm
Shutter - 0.8 mm

Optional Sheet Thickness

Frame - 1.6 / 2.0 mm
Shutter - 1.2 / 1.6 mm

Frame Size

Standard - 102 x 56 mm / 125 x 56 mm
Optional - Architrave

Shutter Thickness

Infill

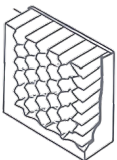

HONEY COMB

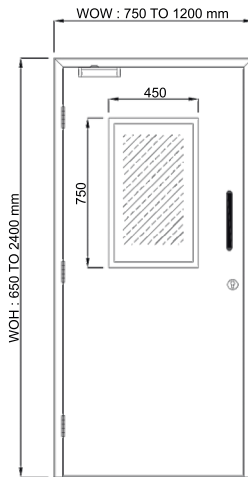

Vision Panel

450 x 750 mm

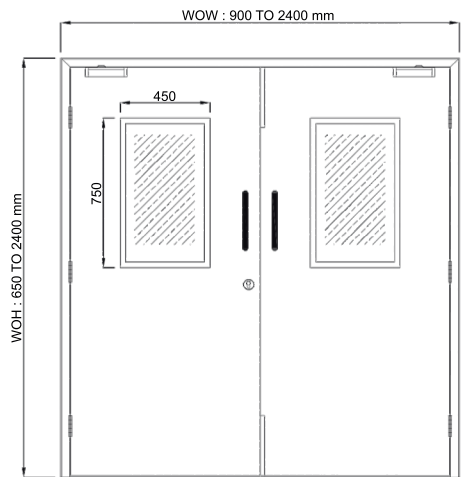

WOW - Wall Opening Width
WOH - Wall Opening Height

Application

- Pharma Units
- Food processing
- Testing Centers and Labs

HOSPITAL DOORS



Material

Galvanized Steel
Stainless Steel

Sheet Thickness

Frame - 1.2 mm
Shutter - 0.8 mm

Optional Sheet Thickness

Frame - 1.6 / 2.0 mm
Shutter - 1.2 / 1.6 mm

Frame Size

Standard - 102 x 56 mm / 125 x 56 mm
Optional - Architrave

Shutter Thickness

46 mm

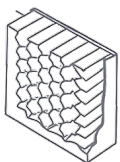

HONEY COMB

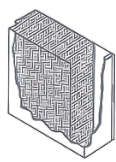

MINERAL WOOL

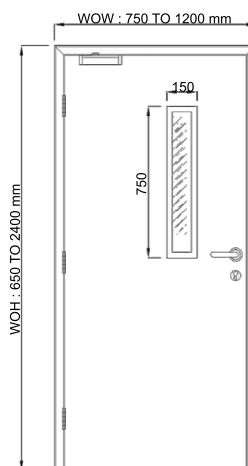

Vision Panel

200 x 300 mm

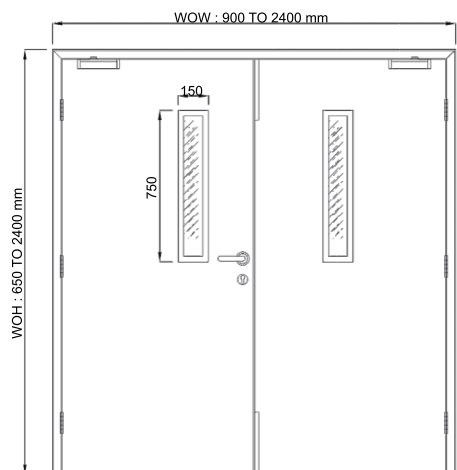

WOW - Wall Opening Width
WOH - Wall Opening Height

Application

- Hospitals
- Corridors
- Ward Rooms
- Consultancy
- Patient Rooms
- Utilities

LEAD LINE DOORS



Material

Galvanized Steel
Stainless Steel

Sheet Thickness

Frame - 1.2 mm
Shutter - 0.8 mm

Optional Sheet Thickness

Frame - 1.6 / 2.0 mm

Frame Size

Standard - 102 x 56 mm
125 x 56 mm

Optional - Architrave

Shutter Thickness

48 mm

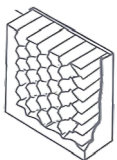

HONEY COMB

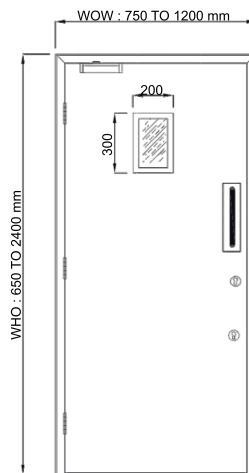

Vision Panel
300 x 300 mm

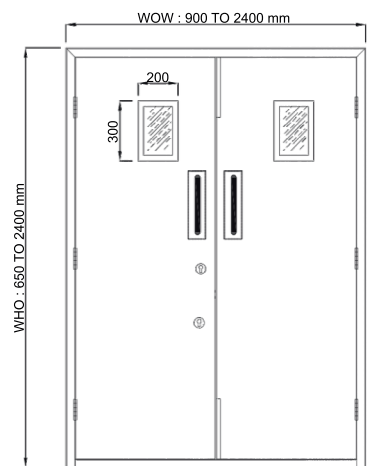

WOW - Wall Opening Width
WHO - Wall Opening Height

Application

-
- CT Scan
- MRI

ACOUSTIC DOORS



Material

Galvanized Steel
Stainless Steel

Sheet Thickness

Frame - 1.2 mm
Shutter - 0.8 mm

Frame Size

Standard - 102 x 56 mm 125 x 56 mm
Optional - Architrave

Shutter Thickness

Infill

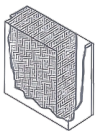

MINERAL WOOL

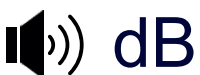

- Single Door 1200 X 2400 - 35dB - Infill HC
 - Single Door 1200 X 2400 - 40dB - Infill MW
 - Double Door 2400 X 2400 - 35dB - Infil HH
 - Double Door 2400 X 2400 - 39dB - Infill MW
- Alldoors with sill and groove frame

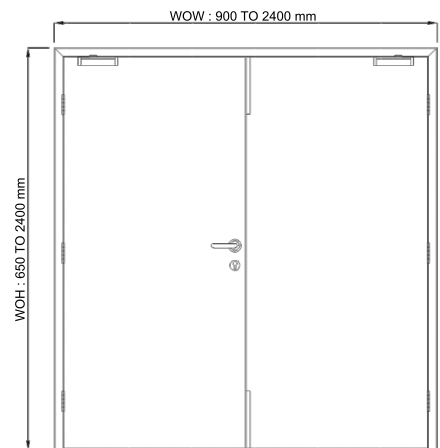
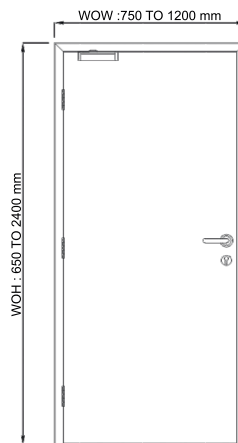

WOW - Wall Opening Width
WOH - Wall Opening Height

Application

- Institutions
- Hospitals
- Public Buildings
- Commercial Buildings
- Airports/Metro

FLIP FLOP DOORS

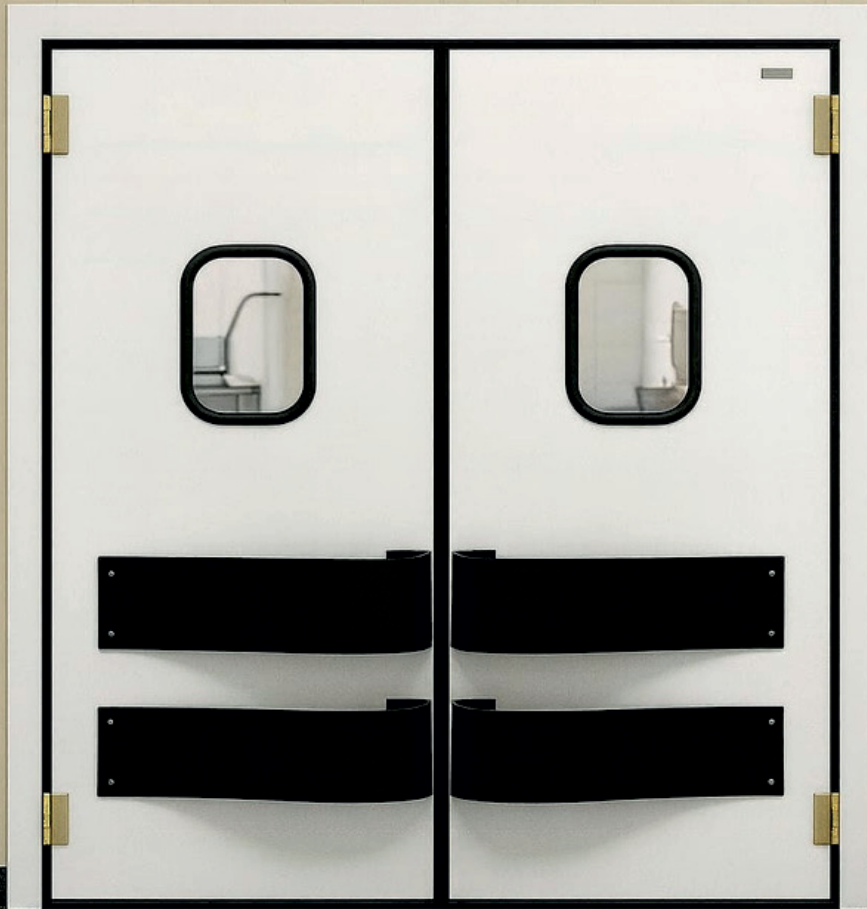

Material

Galvanized Steel
Stainless Steel

Sheet Thickness

Frame - 1.2 mm
Shutter - 0.8 mm

Optional Sheet Thickness

Frame - 1.6 / 2.0 mm
Shutter - 1.2 / 1.6 mm

Frame Size

Standard - 102 x 56 mm / 125 x 56 mm
Optional - Architrave

Shutter Thickness

46 mm / 50 mm

Infill

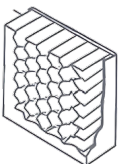

HONEY COMB

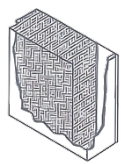

MINERAL WOOL

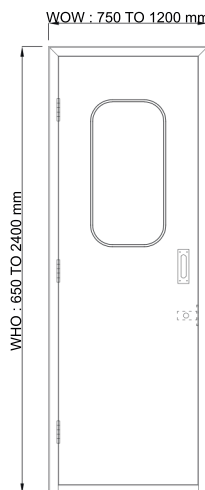

Vision Panel

- 300 x 300 mm
- 300 mm x Diameters

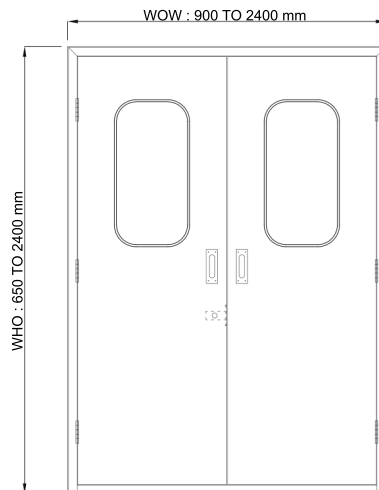
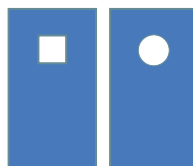

WOW - Wall Opening Width
WHO - Wall Opening Height

Application

- Food Industry
- Cold Stores
- Retail and Supermarkets
- Hospitals

SHAFT DOORS



Material

Galvanized Steel
Stainless Steel

Sheet Thickness

Frame - 1.2 mm
Shutter - 0.8 mm

Optional Sheet Thickness

Frame - 1.6 / 2.0 mm
Shutter - 1.2 / 1.6 mm

Frame Size

Standard - 102 x 56 mm / 125 x 56 mm

Shutter Thickness

46 mm

Infill

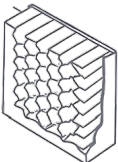

HONEY COMB

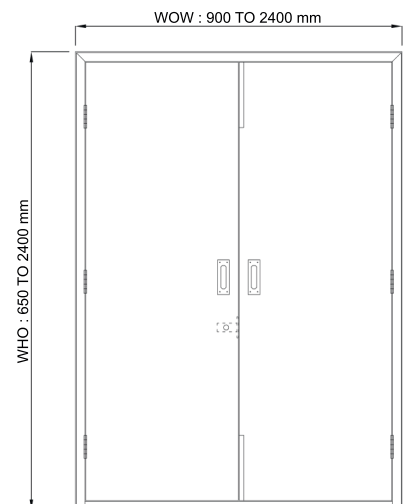
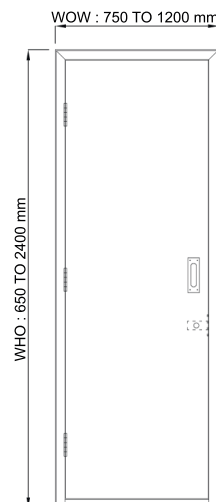

WOW - Wall Opening Width
WHO - Wall Opening Height

Application

- Institutions
- Hospitals
- Public Buildings
- Commercial Buildings
- Airports/Metro

DOOR ELEVATION



F Flush Plain



VP Visio Plain



RP Rectangular Panel



NP Narrow Panel

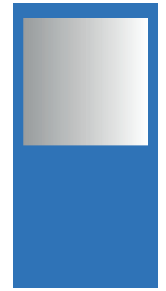

HG Half Glass



N1 Normal Full



C Circle - Vision



FG Full Glass



LB Louver Bottom



LT Lower Top



DL Double Louver

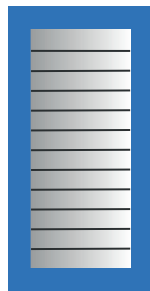

FL Full Louver



GLB Glass Louver Bottom



VLB Vision Louver



NLB Narrow Louver Bottom

There is no limitation to the size of Vision Lite for General Application Doors
Max. Glass Width = Net Door Width - 300 mm

Max. Glass Height = Net Door Height - 400 mm

Alternatively, for larger transparency you can look into our product line - Rail & Door

RAL COLORS



RAL 9010
PURE WHITE

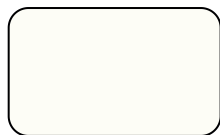

RAL 9016
TRAFFIC WHITE

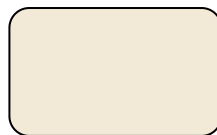

RAL 9001
CREAM

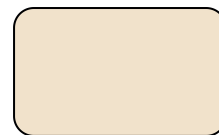

RAL 9002
GREY WHITE

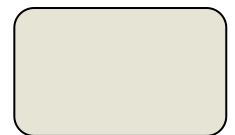

RAL 1013
OYSTER WHITE



RAL 7035
LIGHT GREY



RAL 7040
WINDOW GREY



RAL 5023
DISTANT BLUE



RAL 5015
SKY BLUE



RAL 3020
TRAFFIC RED

OUR DOOR FRAME

Variants

Mitre Joint Butt Joint Welded

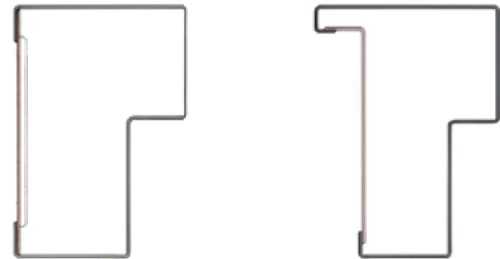

SINGLE REBATE

Options

Architrave on one side Architrave on both sides

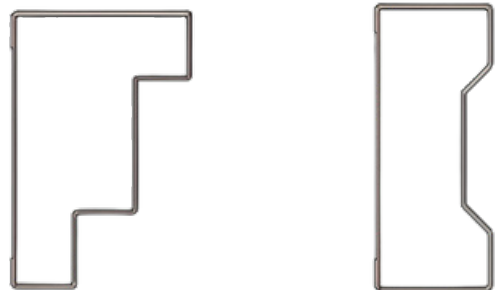

DOUBLE EGRESS

DOUBLE SWING

Sheet Thickness

Up to 150 mm - 1.2 mm

151 & above - 1.6 mm

Frame Depth

Max : 350 mm

Min : 50 mm

Smoke Seal

PVC Seal for Non - Fire Rated EPDM

Gasket for Fire Rated

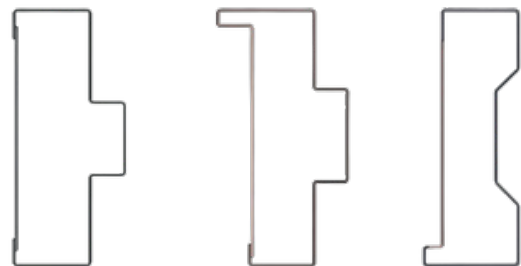

DOUBLE REBATE

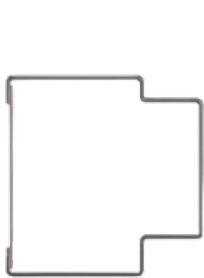

ZERO SOFFIT



WINDOW
PROFILE-SG



WINDOW
PROFILE-DG

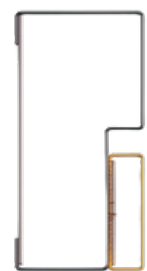

WINDOW
PROFILE

DOOR ENHANCEMENTS FOR YOUR **PEVEETA STEEL DOORS**

At Peveeta, we use only the Finest Quality Hardware and Accessories to ensure our Products Enjoy a Long, Durable, and Damage-free life.



HINGES



D-HANDLE



DEAD LOCK



CONCEALED DOOR
CLOSER



DOOR CLOSER



FLUSH BOLT



DOOR DOWNSEAL



DOUBLE POINT PANIC BAR



SINGLE POINT PANICBAR



MAGNETIC DOOR STOPPER

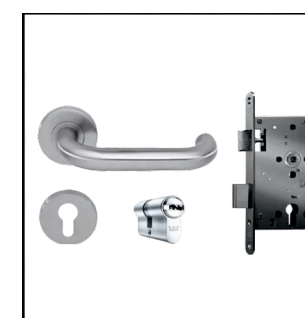

LOCK SET



TOWER BOLT

SHAPING A SUSTAINABLE FUTURE



GREEN VISION

At Peveeta, we are committed to shaping a sustainable tomorrow. We actively support energy conservation, green innovation, and the use of eco-friendly products. Over 60% of the power used at our production facility is generated by our in-house solar power unit.

Our factory and products hold Platinum certification from the Indian Green Building Council, reflecting our dedication to environmental responsibility



SOCIAL COMMITMENT

Every achievement we make opens a doorway to support others. Guided by the principle of enhancing the quality of both society and the environment that sustains us, we strive to create lasting well-being. As a socially responsible company, we dedicate 2% of our net profit each year to building stronger communities, uplifting the underprivileged, and contributing to the greater good of our planet.



Doors for Residential and Industrial

AN ISO 9001-2015 CERTIFIED COMPANY



PEVEETA METALSMITH

Coimbatore, Tamilnadu, India +91

95001 69299, +91 98431 05599

info@peveeta.com

www.peveeta.com

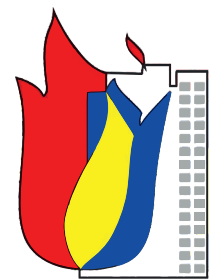

BFRC

Fire Rated Certified